



Residential Doors

New ConceptLine timber doors and new all-glass doors







CONTENT

- 4 Hörmann brand quality
- 6 Good reasons to try Hörmann
- 12 BaseLine
 - Duradecor smooth
 - Duradecor texture
 - Duradecor synchronous texture
 - Real wood veneer
 - Lacquer
- 18 ConceptLine ■ **NEW**
 - Ultra matt
 - Gloss
 - Slate
- 22 DesignLine
 - Plain, Steel, Stripe, Rail
 - Inlay
 - Groove, Groove Glass
 - Georgia
 - Carolina
 - Virginia
- 40 GlassLine ■ **NEW**
- 48 TechnicLine
- 54 Door operator PortaMatic
- 56 Door leaf versions
- 58 Steel frame VarioFix
- 62 Sliding door versions
- 64 Glazing cut-outs / side elements / transom lights
- 66 Lever handle sets
- 70 Handles for sliding doors/fittings for all-glass doors
- 72 Surface finishes
- 76 Overview table
- 78 Technical data

Some of the doors shown are equipped with optional extras and do not always correspond to the standard models. The surface finishes and colours shown are subject to the limitations of the printing process and cannot be regarded as binding. All colours based on RAL.

All rights reserved. No part may be reproduced without our prior permission. Subject to changes.

Discover a new feeling of home: high-quality timber internal doors

Our home is the centre of our life, our safe haven, our oasis of well-being.

As a family business, this spurs us on to provide products made in Germany to give you that special feeling of being at home. Our high-quality timber internal doors contribute to this and provide your home with that extra cosy feeling.

Whether classic or modern, white lacquer or beech, with glass elements or stainless steel embellishments – Hörmann offers you the timber internal door that suits you and your furnishings perfectly.





“A good reputation must be earned.”

August Hörmann

In keeping with the tradition started by the company's founder, the name Hörmann delivers brand name quality with extensive product expertise. The family business has over 80 years of experience as a construction component specialist and sees itself as your partner from the very beginning of building and renovation projects. It's no surprise that Hörmann is one of Europe's most successful internal door providers. This makes a Hörmann internal door a reassuring purchase.



1 Quality products from Germany

The door and frame design are developed by Hörmann in-house. The doors are manufactured based on quality, environmental, energy and workplace safety management guidelines acc. to DIN EN ISO 9001, 14001, 50001 and BS OHSAS 18001 in a modern German factory. In addition, our highly qualified employees work intensively on new products, **continual further developments and improvements to details**. Patents and unique products on the market are the result of this.



2 Internal doors for generations

We are convinced of our products and our uncompromising quality assurance. You can enjoy a Hörmann internal door for years to come **because you are literally choosing a “door for life”**.

3 An eye on the future

Hörmann is setting a good example. This is why the company obtains **100 % of its required energy from green sources**. At the same time, many tonnes of CO₂ are saved each year thanks to the introduction of an intelligent and certified energy management system. For example, using block heating stations saves 1,400 t CO₂. Furthermore, the company uses CO₂-neutral printing for dealer price lists and post. And last but not least, Hörmann offers products for sustainable construction.



4 Diverse product offering

Door leaf and frame combinations to suit every taste

Hörmann has the appropriate door version for your individual decorating style. Fans of the classic look prefer the rebated door leaf and a frame with rounded edges **1**. Those who like clear lines select the same combination with angular edges. The flush-closing door leaf and a frame with angular edges are characterised by a nearly flush-fitting appearance and emphasise a modern home design **2**.

High-quality door leaf

The timber internal doors are available with four different door leaf inserts – from a simple honeycomb insert up to a high-quality solid chipboard.

5 Triple room concepts: ConceptLine

■ NEW

Well thought-out and versatile: the ConceptLine doors offer **new kinds of design possibilities**. Combine the high-quality ultra matt, gloss (high-gloss) and slate surface finishes with the Traffic white, Light grey and Anthracite grey colour variants. Find out more details about the low-maintenance and robust surface finishes on page 18.



6 All-glass doors with nano-coating

■ NEW

Do you want a **light-flooded home**? Then our all-glass doors are the perfect choice for you. Apart from its elegant door appearance, the GlassLine also convinces with regard to ease of care: all styles with sand-blasted glass are equipped with nano-coating for fewer fingerprints.

Styles matching Groove

Matching all-glass doors are available for the DesignLine Groove door styles for the perfect mix of timber and glass doors.

7 Steel profile frame VarioFix

For the new Hörmann steel profile frame VarioFix, wall tolerances of up to 20 mm are no longer a problem: The adjustable decorative rebate easily compensates for different wall thicknesses during renovations and new construction projects. As **easy to fit as a timber frame**, the steel frame is additionally distinguished by its long service life and attractive design. Only VarioFix offers high resistance and an elegant shape without visible foldback coupled with the fitting principle of timber frames. For further information, see pages 58 – 61.



8 Extremely impact-resistant: Duradecor surface

The high-quality surface will delight you: Duradecor features **maximum shock resistance that is 48 % better** than the average of the tested CPL surfaces from other manufacturers. It is also resistant, low-maintenance and heat-resistant allowing you to enjoy your door for years to come.



9 Beautiful and robust: 4Protect edge protector

■ NEW

Our timber internal doors with angular edges and Duradecor white lacquer, Light grey and Anthracite grey surface finishes are **equipped as standard with the high-quality 4Protect edge protector.**

The quadruple edge protection benefits from impressive features:

1. High impact resistance
2. High wear resistance
3. High scratch resistance
4. Perfect joint-free look, meaning that unlike conventional doors, no visible gaps disturb the high-quality appearance of the door.

This makes your timber internal doors more resistant against everyday stress so you can enjoy them for many years to come.



10 See and touch: Duradecor texture

The finely textured surfaces allow you to feel what you see. **A wood grain texture is embossed into the door leaf**, making the characteristic wood structure of the Duradecor texture surface tangible. In the synchronous texture, the wood grain matches the printed surface finish exactly. For the new brushed surface structure, the texture is matched to the brushing in the decor design.

11 Barrier-free living: door operator PortaMatic

Are you physically disabled or would you simply like more convenience? Then equip your internal doors with the innovative door operator PortaMatic. This allows you to **automatically close and open** the doors via a hand transmitter or button, improving your quality of life. For more information, see from page 54.



Plain, chic, timeless

Would you like a timelessly elegant internal door with a welcoming character for your home? Then the door models in the BaseLine series offer you the perfect selection. The solid door leaf in a flush or rebated version – combined with your preferred surface – harmonises wonderfully with your style. This allows you to create a comfortable and relaxing atmosphere.

All BaseLine timber internal doors are available in five high-quality surfaces:

- Duradecor smooth
Particularly impact-resistant in 2 colours and 3 timber designs
- Duradecor texture
Natural character in 9 timber designs
- Duradecor synchronous texture
Perfectly replicated in 3 timber designs
- Real wood veneer
Unique in 3 veneers
- Lacquer
Brilliant in 4 colours or RAL to choose





BaseLine
Duradecor white lacquer
RAL 9016 with Pure
glazing cut-out ■ NEW
 Flush version with
 4Protect edge protector



BaseLine
Duradecor White
Parchment
with glazing cut-out LA 9
 Rebated version



BaseLine
Duradecor White Ash
 Rebated version



BaseLine
Duradecor Light grey
RAL 7035
 Flush version with
 4Protect edge protector



BaseLine
Duradecor Parchment
Light grey
 Rebated version



BaseLine
Duradecor Italian Acacia
 Flush version



BaseLine
Duradecor French Beech
 Rebated version



BaseLine
Duradecor Canadian
Maple
with glazing cut-out
LA 27
 Rebated version



BaseLine
Duradecor texture
Grey Oak
Rebated version



BaseLine
Duradecor texture
White Oak
with glazing cut-out
LA 24
Rebated version



BaseLine
Duradecor texture
Wild Oak
Rebated version



BaseLine
Duradecor texture
Raw Oak
Rebated version



BaseLine
Duradecor texture
Dark Oak
■ **NEW**
Rebated version



BaseLine
Duradecor texture
Walnut
■ **NEW**
Rebated version



BaseLine
Duradecor texture
Spanish Oak
■ NEW
Rebated version



BaseLine
Duradecor texture
Brushed Salted Oak
■ NEW
Rebated version



BaseLine
Duradecor texture
Brushed Pine
■ NEW
Rebated version



BaseLine
Duradecor synchronous
texture Basalt Oak
Flush version



BaseLine
Duradecor synchronous
texture Quartz Oak
Flush version



BaseLine
Duradecor synchronous
texture Fire Oak
Flush version



BaseLine
Real wood veneer Maple
with glazing cut-out LA 9
Rebated version



BaseLine
Real wood veneer Beech
Rebated version



BaseLine
Real wood veneer
White Oak
Rebated version

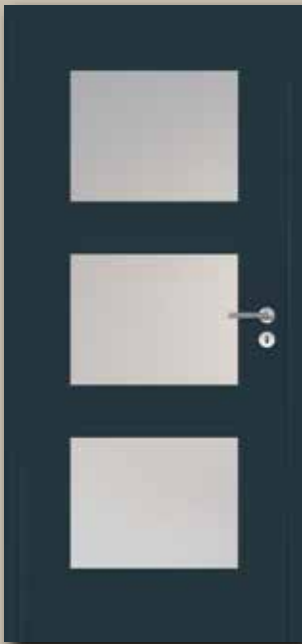

BaseLine
Anthracite grey paint
RAL 7016 with glazing
cut-out LA 11
Flush version with
concealed hinges



BaseLine
White lacquer RAL 9016
Rebated version,
equipped with WC handle
set



BaseLine
Lacquer Light grey
RAL 7035
Rebated version



BaseLine
Lacquer Pure white
RAL 9010
Rebated version



The combination wonder for individual design possibilities

The ConceptLine door models underline a modern and elegant design style with their subtle Traffic white, Light grey and Anthracite grey colours and the three high-quality ultra matt, gloss (high-gloss) and slate surfaces.

- Ultra matt

The particularly elegant silk matt Duradecor surface finish meets the highest demands both visually and haptically. Ultra matt combines the high resistance to fingerprints and soiling with a previously unattainable matt finish.

- Gloss

The elegant high-gloss surface in a crystal look creates special light effects and reflections.

- Slate

The contrast of matt and gloss on the raised texture makes this surface a real eye-catcher in your home.



Three times three possibilities

With the ConceptLine you can stylishly realise individual room concepts. Combine the gloss, ultra matt and slate surface finishes with the Traffic white, Light grey or Anthracite grey colours according to your wishes. They are distinguished by their quality, ease of care and robustness.

An elegant, ultra matt frame provides the design basis for all doors in the different surface finishes.

Which combination best fits your home and fulfils your demands? Discover the beautiful ConceptLine models and all the combination options on the following pages.

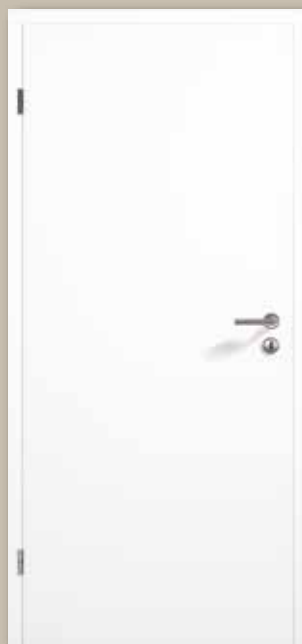

ConceptLine
Duradecor ultra matt
Traffic white RAL 9016
■ NEW
 Rebated version



ConceptLine
Traffic white gloss
RAL 9016
■ NEW
 Rebated version



ConceptLine
Duradecor ultra matt
Anthracite grey
RAL 7016
■ NEW
Rebated version



ConceptLine
Anthracite grey gloss
RAL 7016
■ NEW
Rebated version



ConceptLine
Duradecor Slate
Anthracite grey
RAL 7016
■ NEW
Rebated version



ConceptLine
Duradecor Slate
Traffic white RAL 9016
■ NEW
Rebated version



ConceptLine
Duradecor ultra matt
Light grey RAL 7035
■ NEW
Rebated version



ConceptLine
Light grey gloss
RAL 7035
■ NEW
Rebated version



ConceptLine
Duradecor Slate Light
grey RAL 7035
■ NEW
Rebated version



Discover your dream door

Create the door of your dreams with DesignLine. Whether style elements such as stainless steel embellishments, recessed grooves or modern all-glass doors, whether real wood veneer or paint – the DesignLine offers a variety of modern door styles which you can use to make your home cosy and attractive – while also showing a sense of style. The DesignLine internal doors are available in various versions.

- Plain
With flush-fitting embellishments
- Steel
With surface-mounted embellishments
- Stripe
With embossed grooves
- Inlay
With flush-fitting real wood pilaster strips
- Groove
With recessed grooves
- GrooveGlas
Sand-blasted with silkscreen, matching the Groove timber door styles
- Rail
Timber and glass combinations matching the DesignLine timber door styles



We are dedicated to detail

Subtle details such as embellishments and grooves make your timber internal door an eye-catcher.

For the Plain style, embellishments with a stainless steel look are inlaid flush-fitting in the door leaf.

Surface-mounted embellishments in stainless steel on the door leaf give the Steel styles timelessly elegant contours.

The Stripe 15 style with embossed grooves offers you a subtle design with that certain something.

The Steel, Plain and Stripe styles are available in all decors of the extremely impact-resistant Duradecor* surface finish.

The right timber glass door rail is available for all styles.



Inlaid embellishment in stainless steel look for the Plain style



Surface-mounted embellishment in stainless steel look for the Steel styles

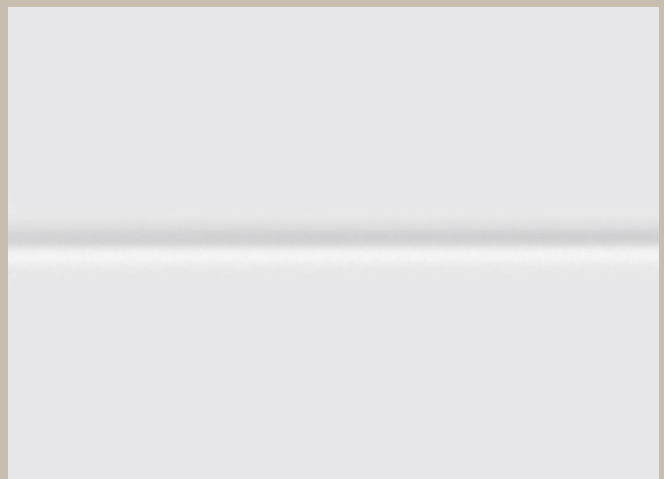

Embossed grooves for style Stripe 15



Plain 27-7
Duradecor Light grey
RAL 7035
 Rebated version



Steel 27
Duradecor white lacquer
RAL 9016
 Rebated version



Stripe 15
Duradecor white lacquer
RAL 9016
■ NEW
 Rebated version



Steel 14
Duradecor white lacquer
RAL 9016
 Flush version with
 concealed hinges



Plain 14-7
Duradecor white lacquer
RAL 9016
■ NEW
 Rebated version



Rail 1
Duradecor White
Parchment
Design glass 2 with
 matt sections
 Rebated version



Steel 20
Duradecor white lacquer
RAL 9016
 Rebated version



Rail 2
Duradecor White Ash
Satinato glass
 Rebated version



Steel 29
Duradecor white lacquer
RAL 9016
■ **NEW**
Rebated version



Plain 29-7
Duradecor Light grey
RAL 7035
■ **NEW**
Rebated version

Harmonious combinations

A small detail with a major effect: the inlaid pilaster strips in Maple or Beech are the highlight of the door style Inlay 26. They fit flush to the door leaf, resulting in a harmonious overall view. The styles Inlay 2 and Inlay 12 in alternating grain patterns provide the door leaf with a unique look. All Inlay styles are available in the real wood veneers Maple, Beech and White Oak.



Steel 16
Duradecor white lacquer
RAL 9016
■ **NEW**
Rebated version



Plain 23-7
Duradecor white lacquer
RAL 9016
■ **NEW**
Rebated version



Inlaid pilaster strips in the door style Inlay 26

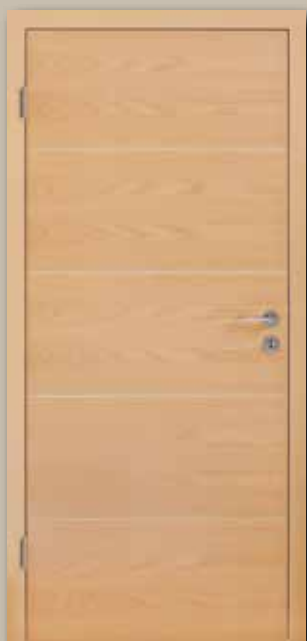

Inlay 26
Real wood veneer Beech
Flush version



Inlay 2
Real wood veneer
White Oak
Rebated version



Rail 1
Real wood veneer
White Oak
Satinato glass
Rebated version



Inlay 12
Real wood veneer Maple
Flush version with
concealed hinges



Rail 2
Real wood veneer Maple
Design glass 2 with matt
sections
Rebated version

The icing on the cake

Recessed grooves are the special feature of the Groove door styles. They are precision milled in the door leaf and the entire door is then coated with high-quality paint. This results in elegant door styles with white surfaces that are a highlight in any room.

The door leaf version with rounded edges showcases the grooves in a particularly elegant manner.

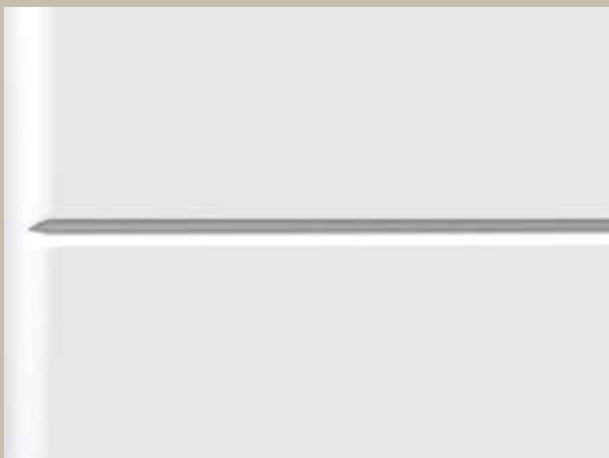

5 mm wide, recessed grooves in the Groove door styles



Groove 15
White lacquer
Rebated version

Harmonious combination



GrooveGlass 15

■ NEW

Single-pane safety glass, sand-blasted, clear surfaces with matt stripes (5 mm wide)

For the perfect combination of timber and glass, the Groove styles are available with matching styles as a glass door with single-pane safety glass. This means that the horizontal lines of the sand-blasted glass doors run exactly at the same height. For glass doors with silkscreen these lines are also adapted to timber doors in the standard sizes. For all other dimensions, the door leaf is visually adjusted. The design of the timber door may differ.

Whatever variants you choose: we guarantee a harmonious and elegant overall appearance.

You can find further information on the glass finishes on page 42.



GrooveGlass 15/5
■ NEW
Single-pane safety glass, sand-blasted, clear surfaces with matt stripes (5 mm wide)



GrooveGlass 15/5
■ NEW
Single-pane safety glass, sand-blasted, matt surfaces with clear stripes (5 mm wide)



GrooveGlass 15/10
■ NEW
Single-pane safety glass, sand-blasted, clear surfaces with matt stripes (10 mm wide)



GrooveGlass 15/10
■ NEW
Single-pane safety glass, sand-blasted, matt surfaces with clear stripes (10 mm wide)



Groove 23
■ NEW
White lacquer
Rebated version



GrooveGlass 23
■ NEW
Single-pane safety glass, sand-blasted, matt surfaces with clear stripe



GrooveGlass 23
■ NEW
Single-pane safety glass, sand-blasted, clear surfaces with matt stripe



Groove 13
White lacquer
Rebated version



GrooveGlass 13
■ **NEW**
Single-pane safety glass, sand-blasted,
clear surfaces with matt stripes



Rail 1
White lacquer
Single-pane safety glass, matt surfaces with clear stripes
Rebated version

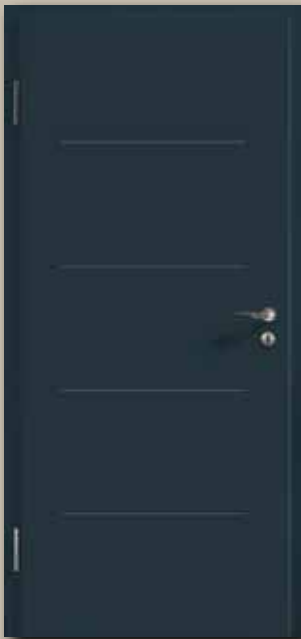

Groove 14
■ **NEW**
Anthracite paint
Rebated version



GrooveGlass 14
■ **NEW**
Single-pane safety glass, sand-blasted,
clear surface with matt stripes



GrooveGlass 14
■ **NEW**
Single-pane safety glass, sand-blasted,
matt surface with clear stripes



Groove 16
■ NEW
White lacquer
Rebated version



GrooveGlass 16
■ NEW
Single-pane safety
glass, sand-blasted,
matt surface with clear
stripes



Groove 20
White lacquer
Rebated version



Rail 2
White lacquer
Single-pane safety
glass, Satinato
Rebated version



GrooveGlass 20
■ NEW
Single-pane safety
glass, V-fluted glass,
clear surfaces with matt
stripes



GrooveGlass 20
■ NEW
Single-pane safety
glass, V-fluted glass,
matt surfaces with clear
stripes



▲ Timber door DesignLine Groove 15, white lacquer RAL 9016, rebated version, All-glass door DesignLine GrooveGlass 15



Groove 29
■ NEW
 White lacquer
 Rebated version



GrooveGlass 29
■ NEW
 Single-pane safety
 glass, sand-blasted,
 matt surfaces with clear
 stripes



GrooveGlass 29
■ NEW
 Single-pane safety
 glass, sand-blasted,
 clear surfaces with matt
 stripes



GrooveGlass 29a
■ NEW
 Single-pane safety
 glass, sand-blasted,
 clear surfaces with matt
 stripe



For fans of the classic look and design aficionados

Do you want a classic look that's also modern? Then our timeless DesignLine styles are the perfect choice for you. Discover your favourite DesignLine door for the perfect country house style.

- Georgia
Exclusive door styles with inserted profile strip
- Carolina
Inexpensive door style with embossed profile
- Virginia
High-quality panel doors in an elegant design



High-quality details, elegant appearance

For the perfect country look, we recommend the exclusive Georgia door styles. The high-quality profile strip is inlaid into grooves in the door frame using traditional carpentry techniques, lending these styles an elegant appearance. The Georgia door styles are available in all Duradecor* and lacquer surface finishes as well as real wood veneer in White Oak.



Inlaid profile strip for the Georgia door styles



Georgia 1
Duradecor white lacquer
RAL 9016
Rebated version



Georgia 2
Duradecor white lacquer
RAL 9016
Rebated version



Georgia 4
Duradecor white lacquer
RAL 9016
Rebated version



Georgia 1
Real wood veneer White Oak
Rebated version



Georgia 2
Real wood veneer White Oak
Rebated version



Georgia 4
Real wood veneer White Oak
Rebated version



Georgia 1
White lacquer
Rebated version



Georgia 2
White lacquer
Rebated version



Georgia 4
White lacquer with glazing cut-out
Rebated version

Beauty that is more than skin deep

The Carolina doors have a clean, classic look. The panel frames are created by an embossed profile in the door leaf. A paint coating on a white base plate gives the styles a smooth, brilliant colour surface.



Embossed profile for the Carolina door styles



Carolina 1
White lacquer
Rebated version



Carolina 2
White lacquer
Rebated version



Carolina 4
White lacquer
Rebated version

The perfect frame for a beautiful home

Make your home more beautiful with the classic frame infill doors, also known as panel doors. This door version consists of a frame construction with up to 2 friezes. The sections can be filled either with a glazing or a timber board. The Virginia is available with one, two or three sections.

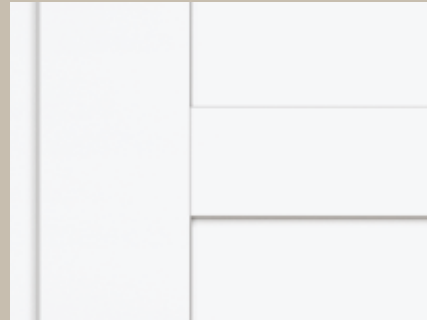

Vertical frame around a horizontal frieze



Virginia 1
■ NEW
White lacquer decor with
1 window section
Rebated version



Virginia 2
■ NEW
White lacquer decor with
2 timber sections
Rebated version



Virginia 3
■ NEW
White lacquer decor with
3 window sections
Rebated version



Welcome to the light-flooded home

Glass doors are not only upmarket and chic, they contribute to an open and friendly design for your home and lend each room a particular charm. Whether classic or with playful details – find the suitable glass door from our wide range that will turn your home into an oasis of well-being. All-glass doors are optionally available as a leaf door with a timber frame or a VarioFix frame as well as a sliding door with single-pane safety glass. The glass doors are equipped with different glass finishes depending on the style:

- Silkscreen
Particularly scratch-resistant surface, easy to clean and resistant to soiling
- Sand-blasting
Matt surface finish with nano-coating for fewer fingerprints
- Laser technique
Creates fine details and shading
- Fluted glass
Particularly elegant due to fine V-groove

For further information, please see page 42.



High-quality glass finishes



Silkscreen

For the silkscreen procedure a ceramic Satinato look is baked into the glass resulting in a sealed, resistant surface finish. Silkscreen is characterised by the following features:

- Particularly scratch-resistant surface, comfortable feel
- Easy to clean, resistant to soiling
- Resistant to stress



Sand-blasting

Light falling through sand-blasted glass doors appears relatively soft, i.e. somewhat "dimmed". Individual style requests can also be fulfilled with this technique. Characteristic for sand-blasting:

- Subtle, matt surface finish
- Soft light
- Easy to clean thanks to nano-coating for fewer fingerprints



Laser technique

With this procedure, a small part of the glass is melted with a laser. This causes little dots that appear white due to light refraction. The result is fine details and shading on the glass. This is what distinguishes the laser technique:

- Sealed, resistant surface finish
- High durability
- Shimmering light effect



Fluted glass

The fluted glass on the glass door is created by a fine V-groove. A clear or satin-finished glass is used depending on the preferred opaqueness. This is what distinguishes the fluted glass:

- Special design
- Tangible feel
- Extraordinary play of light created by the prismatic effect



Corbus
 ■ NEW
 Single-pane safety glass, sand-blasted, clear surface with matt rectangles



Corbus
 ■ NEW
 Single-pane safety glass, sand-blasted, matt surfaces with clear rectangles



Agesa
 ■ NEW
 Single-pane safety glass, sand-blasted, clear surfaces with matt stripes



Samu
 ■ NEW
 Single-pane safety glass, technical sand-blasting, matt and clear surfaces with matt stripes



Aldo
 ■ NEW
 Single-pane safety glass, sand-blasted, matt surfaces with clear stripes



Karson
 ■ NEW
 Single-pane safety glass, sand-blasted, matt surfaces with clear stripes



Isa
 ■ NEW
 Single-pane safety glass, laser technique, clear surfaces with matt stripes



Isa duo
 ■ NEW
 Single-pane safety glass, laser technique, clear surfaces with matt stripes



Lines
 ■ NEW
 Single-pane safety glass, laser technique, clear surfaces with matt stripes



Jada
 ■ NEW
 Single-pane safety glass, sand-blasted, clear and matt surfaces with clear and matt stripes



Raff
 ■ NEW
 Single-pane safety glass, sand-blasted, clear surfaces with matt stripes



Bamante
 ■ NEW
 Single-pane safety glass, sand-blasted, matt and clear surfaces with matt stripes



Liko
 ■ NEW
 Single-pane safety glass, sand-blasted, clear surfaces with matt stripes



Lane
 ■ NEW
 Single-pane safety glass, sand-blasted, clear surfaces with matt stripes



Saha
 ■ NEW
 Single-pane safety glass, sand-blasted, clear surfaces with matt stripes



Gropus
 ■ NEW
 Single-pane safety glass, V-fluted glass, matt surface with clear stripes



Rika
■ NEW
 Single-pane safety glass, silkscreen, clear surface with matt rectangles



Wildlife
■ NEW
 Single-pane safety glass, sand-blasted, clear surfaces with matt stripes



Neblio
■ NEW
 Single-pane safety glass, graduated silkscreen, matt surfaces blend into clear surfaces



Lito
■ NEW
 Single-pane safety glass, laser technique, clear surfaces with matt text



Privat
■ NEW
 Single-pane safety glass, sand-blasted, style to choose, shown: matt surfaces with clear text



Graphic
■ NEW
 Single-pane safety glass, sand-blasted, clear surfaces with matt stripes



Gisa
■ NEW
 Single-pane safety glass, silkscreen, matt surfaces with clear stripes



Coco
■ NEW
 Single-pane safety glass, V-fluted glass, matt surface with clear stripes



Coco
■ NEW
Single-pane safety glass, V-fluted glass, clear surface with matt stripes



Jil
■ NEW
Single-pane safety glass, sand-blasted, clear surfaces with matt stripes



Wave
■ NEW
Single-pane safety glass, sand-blasted, matt surface with clear stripe







A feeling of security for you and your family

Many TechnicLine styles are available as secure apartment entrance doors, and nearly all BaseLine (without glazing cut-out) and DesignLine door styles are available as heavy-duty fire-rated doors. In addition, you have the option of equipping your timber door with special functions, such as a wide-angle camera. This gives you a feeling of security, especially if you are home alone.



Apartment entrance door with climatic class 3 and acoustic rating category 2

Apartment entrance doors WAT

Door styles

- BaseLine without glazing cut-out
- DesignLine: Steel, Plain, Groove, Inlay, Georgia (with contour-milled profile strip)

Door leaf versions

- Rebated angular
- Rebated round
- Single-leaf

Version WAT Klima 3 SK2



- Climatic class III
- Acoustic rating category 2 (37 dB)

Version WAT Klima 3 SK3



- Climatic class III
- Acoustic rating category 3 (42 dB)

Version WAT Klima 3 SK2 RC 2



- Climatic class III
- Acoustic rating category 2 (37 dB)
- Security equipment RC 2 (3-point locking with stainless steel lock cover)



Optional protective fitting ES 2 for RC 2 security equipment



Additional locking at bottom in the optional RC 2 security version



Optional VX hinge for increased security

T30 fire-rated doors

Door styles

- BaseLine without glazing cut-out

Door leaf versions

- Rebated angular
- Rebated round
- Single-leaf and double-leaf (break-in-resistant RC 2 only for single-leaf)

Version T30 Klima 2



- T30 fire-retarding (DIN 4102-4)
- Climatic class II (DIN EN 12219)
- Single-leaf: slide rail overhead door closer HDC 35
- Double-leaf: slide rail overhead door closer TS 5000 ISM
- Fire-proof plastic lever handle with short escutcheon

Version T30 Klima 3 SK 2 RS



- Fire-retarding (DIN 4102-4)
- Smoke-tight (DIN 18095, DIN EN 1634-01)
- Acoustic rating category 2 (37 dB)
- Climatic class III (DIN EN 12219)
- Single-leaf: slide rail overhead door closer HDC 35
- Double-leaf: slide rail overhead door closer TS 5000 ISM
- Fire-proof plastic lever handle with short escutcheon

Version T30 Klima 3 SK 2 RS RC 2



- T30 fire-retarding (DIN 4102-4)
- Smoke-tight (DIN 18095, DIN EN 1634-01)
- Acoustic rating category 2 (37 dB)
- Climatic class III (DIN EN 12219)
- Break-in-resistant RC 2 (DIN EN 1627)
- Single-leaf: slide rail overhead door closer HDC 35
- Fire-proof plastic lever handle with short escutcheon
- 3-point locking with stainless steel lock cover



Slide rail overhead door closer HDC 35

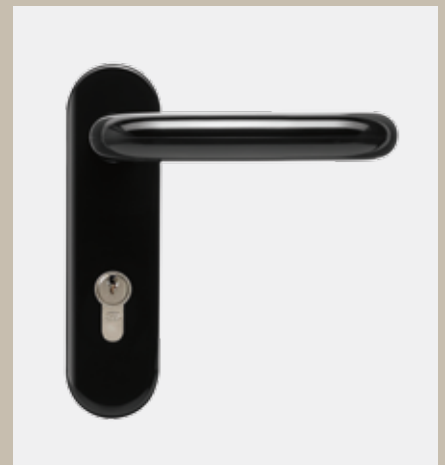

Fire protection lever (profile cylinder not included in the scope of delivery)



VX hinge



Optional accessories

The door styles of the TechnicLine can be additionally equipped with optional accessories. Whether spyhole, e-spyhole, electric strike or motor lock, our optional extras fulfil all your requirements for safe and comfortable living.



Spyhole

A must for more safety: With a spyhole, you can see who is standing in front of your door at any time without having to open it.



E-spyhole with LCD display

Looking through the spyhole often poses problems for children, people who wear glasses or the elderly. The wide angle camera is a convenient solution for seeing exactly who is outside your door.



Electric strike

With the electronic strike catch, you can conveniently open your door via a switch inside the home.



Motor lock

Practical, convenient and safe – the motor lock automatically locks your entrance door.

Open and close doors effortlessly

With the Hörmann PortaMatic door operator, you can open and close your timber and steel internal doors automatically via hand transmitter or button. Whether you are physically disabled or would simply like more convenience – this technology will make your everyday life easier. The door operator PortaMatic features not only an array of functions and settings, but also minimal power consumption. In addition, the PortaMatic is up to 25% cheaper than similar door operators.



For additional information, consult the Door Operator PortaMatic brochure.





Senior-friendly residences

Would you like to stay mobile despite physical limitations? The PortaMatic operator for internal doors improves your quality of life by helping you move about your home unaided.

Convenient living

You can now carry full trays, heavy crates of beverages or your shopping bags into your rooms unhindered. Even if you don't need the automatic door operator PortaMatic for health reasons, you will never want to do without this convenience again – we guarantee it!

Barrier-free working

Barrier-free working already plays an important role and will continue to gain importance in the future. The PortaMatic door operator can be integrated into all non-public areas at your workplace, thus ensuring more convenience.

Hygienic door operation

In office buildings, the risk of infection among employees is especially high on doors leading to the lavatory. In combination with a non-contact switch, the PortaMatic door operator provides reliable protection from germs and bacteria, giving you a sense of security.





Flush version

The flush closing door leaf offers an exclusive door appearance with a practically seamless transition to the frame and emphasises modern home design.

Lock



Standard: deadlock, Class I, lock cover in nickel silver



Optional: magnetic latch lock

Hinges



Guide roller V 7888 WF 3D (standard), only for timber frames



Concealed 3D hinge DX 61 (optional)



Rebated version

The rebated version is available in two edge versions. The version with angular edges creates clear contours while the rebated door leaf with rounded edges provides a harmonic Softline look.

Lock



Rebated door with angular edge

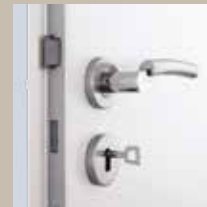

Standard: deadlock, Class I, lock cover in nickel silver

Hinges



Guide roller V 3420 WF (as standard)

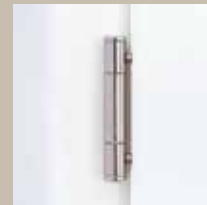

Guide roller V 4426 WF (optional)



3D hinge VX 100-18 (optional)



Concealed hinge Pivota FX 2 60 3D (optional)



The robust steel frame VarioFix

In addition to the standard timber frames, all our internal doors are also available with the steel frame VarioFix. It is the ideal solution for apartment entrance doors and internal doors in the home and project sector where high resistance and durability are necessary.

The VarioFix frame harmonises perfectly with other timber frames due to the frame face of 55 mm on both sides. This way, you can also use doors with different frames in one room or house.

For the steel frame VarioFix, wall tolerances of up to 20 mm are no problem. The adjustable decorative rebate easily compensates for different wall thicknesses during renovations and new construction projects.

The VarioFix frame is available in Traffic white RAL 9016 to match our door leaves in Duradecor white lacquer and paint as well as in RAL to choose.



The frame face of 55 mm on both sides of the VarioFix frame (fig. left) harmonises perfectly with timber frames (fig. right).



The VarioFix frame is especially robust and can withstand "accidents" with toy cars or run-ins with the Hoover.



The VarioFix frame is also suited for apartment doors with RC 2 security equipment and acoustic insulation.



VarioFix: the steel frame with many benefits

Especially resistant to damage **1**

The robust VarioFix frame can also take a collision with a toy car or your Hoover. In such cases edges on timber frames can be damaged or even chipped.



Resistant to cleaning water **2**

The VarioFix frame is the perfect solution for rooms with tiled floors. Thanks to the high-quality galvanization, even cleaning water cannot damage the frame. With timber frames there is a danger that the bottom frame edge will swell or that it must be sealed with an unattractive silicone joint.



Invisible mitre cut **3**

For the powder-coated steel frame VarioFix, the corner joints feature high-quality welding and a flush polish, meaning there are no visible mitre cuts in the frame corners, in contrast to timber frames.

Uniform gap dimension for flush-closing doors **4**

Due to the stable steel construction, the VarioFix frame cannot warp after fitting. This guarantees a uniform gap dimension for flush-closing doors and ensures a harmonious and elegant door appearance.



Our space-saving marvels: sliding doors

Sliding doors open up new possibilities for ideal use of your living space. Hörmann offers sliding door solutions for every living situation. All door styles in BaseLine and DesignLine as well as in GlassLine are available as sliding doors.



With the brush on the door leaf (figure on left) and the optional inlet seal in the frame (figure on right), Hörmann sliding doors offer optimal protection against odours, noise and draughts – for even more comfort in your own home.

Sliding door box type A, for double-leaf sliding doors

When fitted in front of the wall, the door leaf slides on two guide rails mounted in the sliding door box. When fitted running within the wall, the guide rails are fitted in an on-site door pocket in the wall. This eliminates the sliding door box. The wall opening is concealed by the frame.

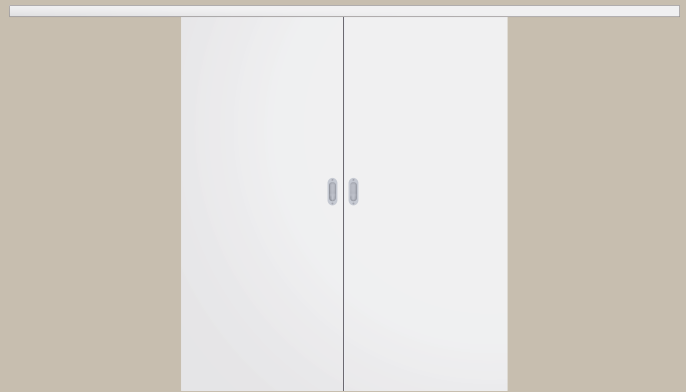

Running in front of the wall: frame, guide rail panelling and door leaf form a harmonious unit



Running within the wall: door leaf is inserted into an on-site door pocket in the wall, the frame completely conceals the wall opening

Sliding door box type C, for single-leaf sliding doors

In addition to the horizontal side guides, this version also has a vertical stop fitted in the frame. This makes it possible to also have locking functions or other optional extras such as an inlet seal for better protection against odours, noise and draughts.



Running in front of the wall, opening towards the left



Running within the wall, opening towards the left

Sliding door system Slide Compact for single and double-leaf sliding doors

With this system, the door leaves slide in a guide rail profile. The profile in a stainless steel colour can be fitted both in front of the wall and on the ceiling. For a door leaf weight of up to 60 kg, the Slide Compact system is equipped with a SafeClose in order to gently close the door leaves.

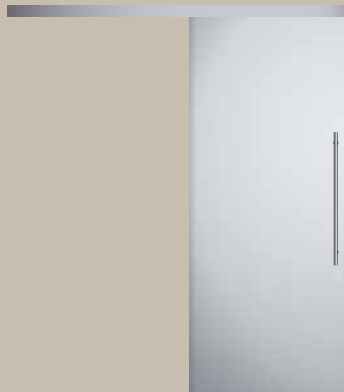

Running in front of the wall, opening towards the left



Running in front of the wall



Slide Compact with glass door

Glazing cut-outs

With our selection of glazing cut-outs, you can take your favourite style and make the personalised door of your dreams. Glazing cut-outs are available in the glazing of your choice.

Side elements and transom lights

Side elements and transom lights flood your living spaces with light for a special flair. While side elements visually enhance the door sets, transom lights emphasise the room height. Top panels underscore the ceiling-high appearance of the door set.



Glazing cut-outs

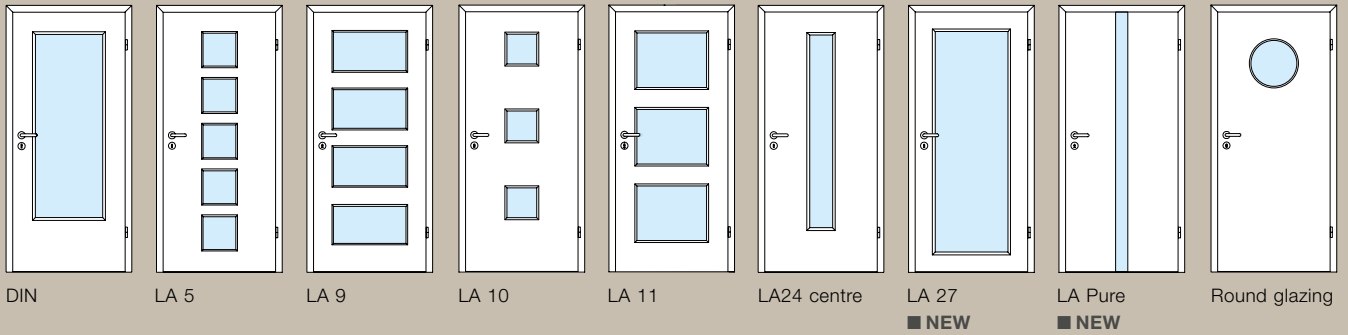

All door styles in the DesignLines Georgia, Vermont and Carolina are available with glazing in the upper panels.

Side elements

(lintel-high)

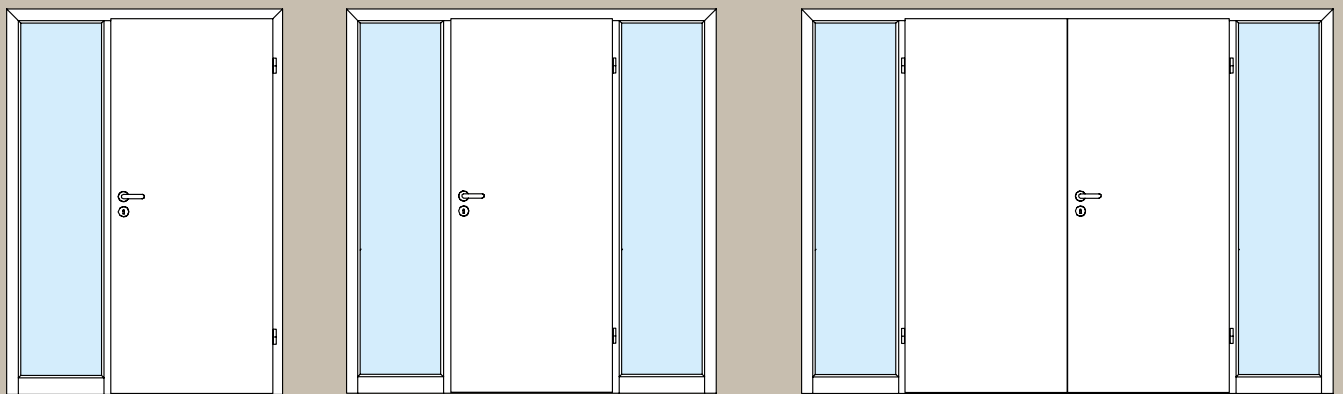

Single-leaf, 1 side element

Single-leaf, 2 side elements

Double-leaf, 2 side elements

Transom lights

(ceiling-high)

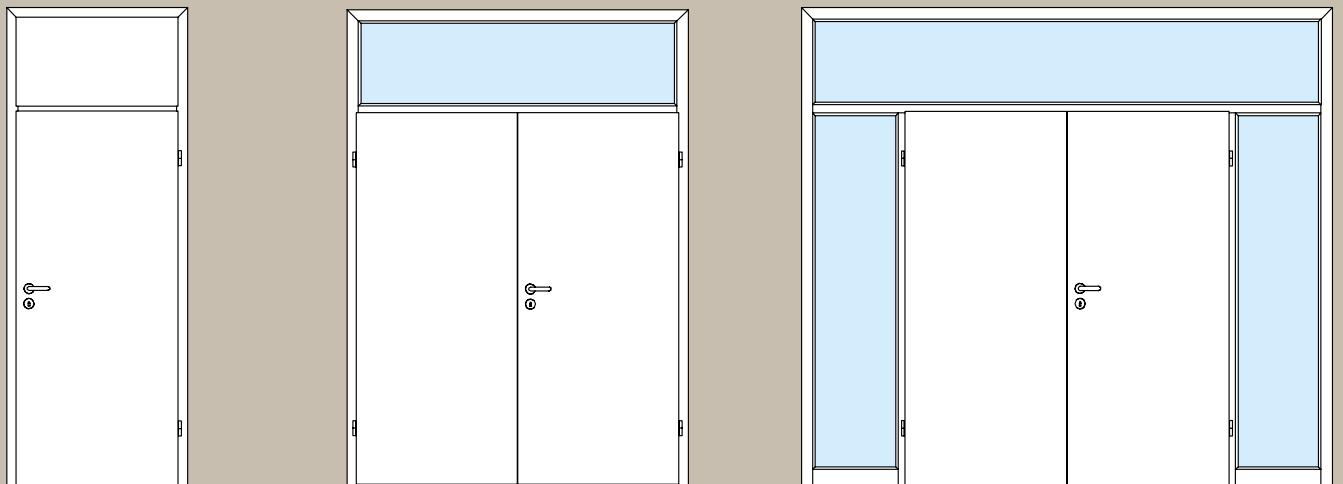

Single-leaf, 1 transom panel,
alternatively also with transom
light

Double-leaf, 1 transom light

Double-leaf, 2 side elements, 1 transom light

Handle sets to suit every taste

Whether classic or modern, angular or rounded – Hörmann offers you a wide range of elegant and high-quality lever handle sets for the BaseLine, ConceptLine, DesignLine and TechnicLine door models.



For an especially elegant door appearance, all lever handles are optionally available in a flush-fitting Planar variant.

Handles for door leaves



Ala
Brushed matt stainless steel



Contra
Brushed matt stainless steel



Senso
Brushed matt stainless steel

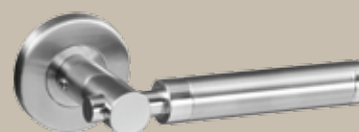

Arundo
Brushed matt stainless steel

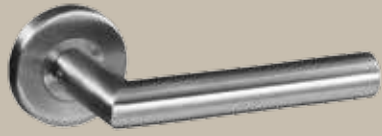

Linea
Brushed matt stainless steel



Indra
Round rose escutcheon, matt / polished stainless steel

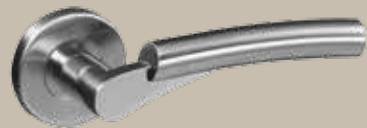

Tento
Brushed matt stainless steel



Basica 2
Round rose escutcheon, matt stainless steel



Vallis
Brushed matt stainless steel



Basica 3
Round rose escutcheon, matt stainless steel



Vento
Brushed matt stainless steel



Luba
Round rose escutcheon, matt stainless steel



Dee
Round rose escutcheon, matt stainless steel



Linea
Round flat rose escutcheon, polished stainless steel



Apart
Round rose escutcheon, matt stainless steel



Quadriga
Square rose escutcheon, matt stainless steel

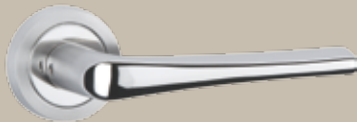

Selecta
Round rose escutcheon, matt / polished stainless steel



Contur
Square rose escutcheon, matt stainless steel



Linea
Round flat rose escutcheon, matt stainless steel

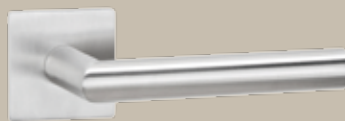

Linea
Square flat rose escutcheon, matt stainless steel

The pictured handles are optionally available in the following versions:

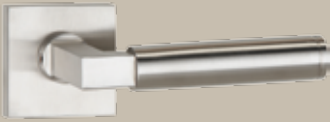

Dee
Square flat rose escutcheon, matt stainless steel

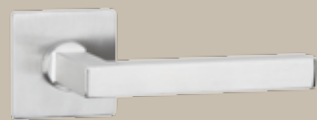

Grafica
Square flat rose escutcheon, matt stainless steel

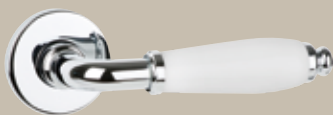

Lilet
Round rose escutcheon, polished stainless steel,
white porcelain handle



PC handle set (cylinder optional)



Deadlock handle set



WC handle set



PC lever/knob handle set with door knob

Beautifully shaped handles that are simply impressive

Personalise your sliding door with the handle of your choice. We offer handles for glass doors and timber doors that tastefully complete the look of your sliding door.

Handles for sliding doors



Handle recess, oval, matt stainless steel (for timber doors)



Handle recess, round, matt stainless steel (for timber doors)



Handle recess, angular, matt stainless steel (for timber doors)



Handle recess, round, closed, matt stainless steel (for glass doors)



Handle recess, angular, closed, matt stainless steel (for glass doors)



Handle bar pair Basic, round, Ø 25 mm, 400 mm length, matt stainless steel



Handle bar pair Basic, angular, 500 mm length, matt stainless steel



Handle bar pair Combi, push bar with one-sided handle plate, 400 mm length, matt stainless steel



For sliding doors that run within the wall, you can conceal the door leaf completely in the wall with a trip handle. The handle springs out at the press of a button, allowing you to close the door.

Fittings for all-glass doors

For all-glass doors you can choose between a round and an angular fitting set, which can each be combined with one of eight elegant stainless steel lever handles. Each variant is available in a lockable and non-locking version.



Fitting set Aronda



Fitting set Purista



Basica 1



Basica 3

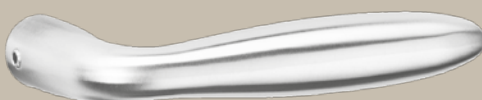

Bellis



Dee



Grafica



Quadrigrà



Apart



Nala

Benefit from impressive performance features: Duradecor

With regard to ease of care and robustness, Duradecor cannot be beaten – it is almost as durable as a kitchen countertop.

- 48 % more impact-resistant than the average of the tested CPL surfaces from other manufacturers
- Hygienic and low-maintenance
- Strong antistatic and colour-fast properties
- Resistant to heat and abrasion
- Stands up to normal household fluids, pastes, etc.

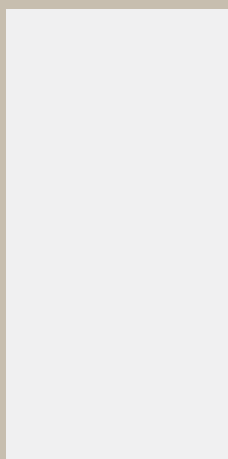

White lacquer
RAL 9016



Light grey
RAL 7035

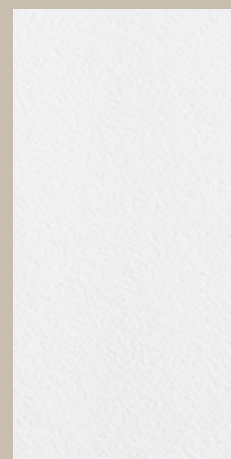

White Parchment

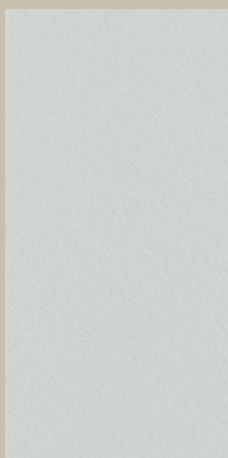

Light Grey
Parchment

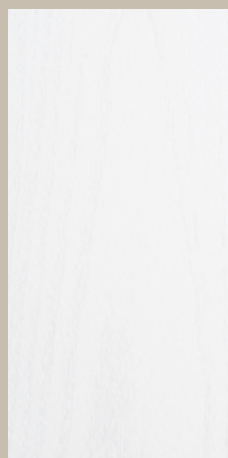

White Ash



Italian Acacia



Canadian Maple



French Beech



Duradecor texture

Duradecor synchronous texture



Grey Oak
(also in horizontal grains)



White Oak
(also in horizontal grains)



Wild Oak
(also in horizontal grains)



Quartz Oak



Red Oak
(also in horizontal grains)



Dark Oak
■ NEW



Spanish Oak ■ NEW
(also in horizontal grains)



Basalt Oak



Walnut
■ NEW



Brushed Salted Oak
■ NEW



Brushed Pine
■ NEW



Fire Oak

Ultra matt, gloss, slate

The ConceptLine surfaces impress with some very special qualities: anti-fingerprint for ultra matt, extremely smooth surface finish for gloss and an elegant light and shade effect for slate.

Ultra matt surface finish ■ NEW

- Velvety feel
- Duradecor surface with maximum impact resistance
- 4Protect edge protector
- Anti-fingerprint to minimise fingerprints and soiling
- Can be coloured with chalk

Gloss surface finish ■ NEW

- High-gloss
- Extremely smooth surface finish
- Highly durable
- 4Protect edge protector

Slate surface finish ■ NEW

- Raised texture creates a natural play of colours
- Duradecor surface with maximum impact resistance
- 4Protect edge protector

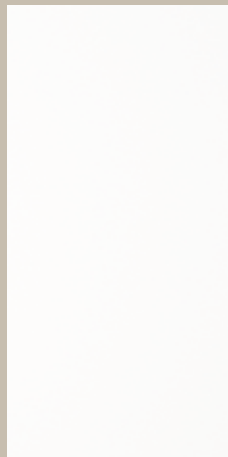

Ultra matt
Traffic white
RAL 9016

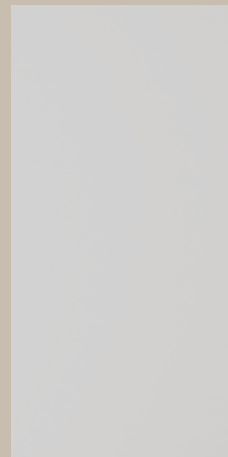

Ultra matt
Light grey
RAL 7035



Ultra matt
Anthracite grey
RAL 7016



Traffic white
gloss
RAL 9016



Light grey
gloss
RAL 7035



Anthracite grey
gloss
RAL 7016



Slate
Traffic white
RAL 9016

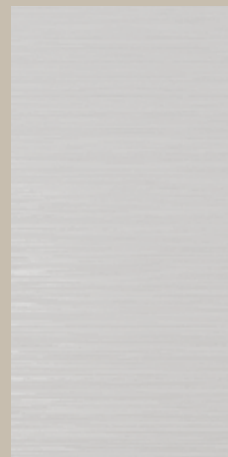

Slate
Light grey
RAL 7035



Slate
Anthracite grey
RAL 7016

Lacquer

Find out about the high-quality Hörmann lacquer surface finish:

- Smooth surface
- Rich, vibrant colour
- Paint coating on a white base plate
- On request in RAL to choose

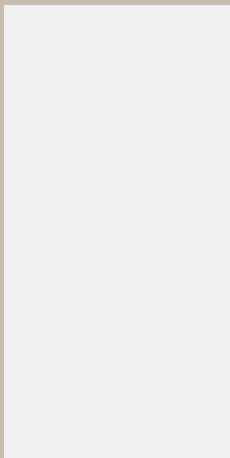

Traffic white
RAL 9016

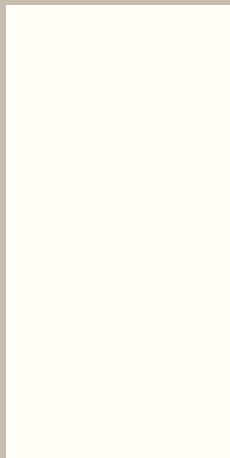

Pure white
RAL 9010

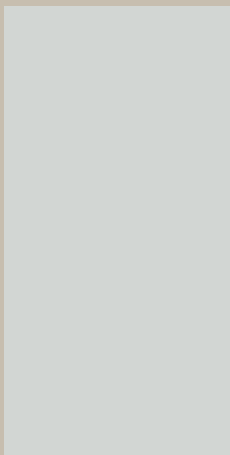

Light grey
RAL 7035

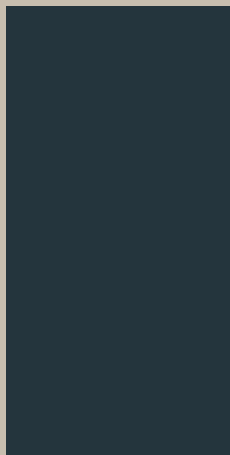

Anthracite grey
RAL 7016

Real wood veneer

Just as every tree is different, so too each of our real wood veneers is unique:

- Made of high-quality real timber
- Environmentally-friendly protective paint for durable surface protection
- Natural wood grain
- Long-lasting quality



Maple





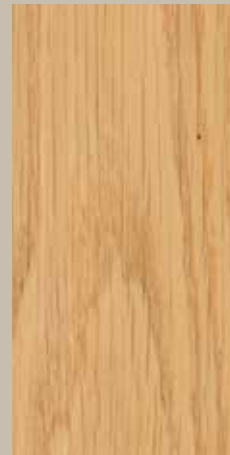



















Beech



White Oak

Door styles

	BaseLine	Concept-Line	Design-Line Steel	Design-Line Plain	Design-Line Stripe	Design-Line Groove	Design-Line Inlay	Design-Line Rail	Design-Line Georgia	Design-Line Carolina	Design-Line Virginia	
Surface finishes												
Duradecor												
Rebated angular		●	-	●	●	○	-	-	●	●	-	-
Rebated round		●	-	●	●	-	-	-	●	●	-	●
Flush angular		●	-	●	●	○	-	-	●	●	-	-
Duradecor synchronous texture												
Rebated angular		●	-	-	-	-	-	-	-	-	-	-
Rebated round		-	-	-	-	-	-	-	-	-	-	-
Flush angular		●	-	-	-	-	-	-	-	-	-	-
Duradecor texture												
Rebated angular		●	-	●	●	-	-	-	●	○	-	-
Rebated round		●	-	●	●	-	-	-	●	○	-	-
Flush angular		●	-	●	●	-	-	-	●	○	-	-
Real wood veneer												
Rebated angular		●	-	-	-	-	-	●	●	○	-	-
Rebated round		○	-	-	-	-	-	○	○	○	-	-
Flush angular		●	-	-	-	-	-	●	●	○	-	-
Lacquer												
Rebated angular		●	-	●	●	-	●	-	●	●	-	-
Rebated round		●	-	●	●	-	●	-	●	●	○	-
Flush angular		●	-	●	●	-	●	-	●	●	-	-
Gloss												
Rebated angular		-	●	-	-	-	-	-	-	-	-	-
Flush angular		-	●	-	-	-	-	-	-	-	-	-
Ultra matt												
Rebated angular		-	●	-	●	-	-	-	-	-	-	-
Rebated round		-	●	-	●	-	-	-	-	-	-	-
Flush angular		-	●	-	●	-	-	-	-	-	-	-
Slate												
Rebated angular		-	●	-	-	-	-	-	-	-	-	-
Flush angular		-	●	-	-	-	-	-	-	-	-	-

● = available for all decors / colours
○ = not available for all decors / colours

Door leaf insert

Honeycomb insert	Tubular chipboard spacers	Tubular chipboard plate	Solid chipboard
-	-	●	●
-	●	●	●
-	-	●	●
-	-	●	●
-	-	-	-
-	-	●	●
-	-	-	-
-	-	●	●
-	-	-	-
-	●	●	●
-	○	○	○
-	●	●	●
-	-	●	●
-	●	●	●
-	●	●	●
-	-	●	●
-	-	●	●
-	-	●	●
-	-	●	●
-	-	●	●
-	-	●	●
-	-	●	●
-	-	●	●



Honeycomb insert

The honeycomb insert retains its shape and has an excellent price-performance ratio.



Tubular chipboard spacers

The door leaf insert consists of individual spacers that are arranged in the best possible layout. This causes the door leaf to be especially sturdy and suitable for heavy wear.



Tubular chipboard plate

The solid plate with horizontal tubes gives door leaves high surface stability. These high-quality internal doors are suitable for even heavier wear.



Solid chipboard

The high-quality solid chipboard door leaves have the highest leaf rigidity and are suitable for especially heavy wear. Doors with glazing cut-outs are available with solid chipboard as standard.

Frame types



Profile frame with rounded edges

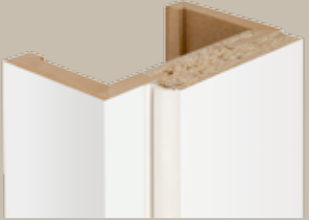

Profile frame with angular edges



Profile frame with profile for DesignLine Georgia and Carolina



Block frame

Door leaf

- Approx. 40 mm thick (TechnicLine approx. 46 mm thick)
- Frame construction made of solid timber/timber material with additional frame reinforcement, can be shortened by 25 mm at bottom
- For double-leaf doors: with counter rebate*
- Climatic class I (TechnicLine climatic class III) duty category N to S (according to version)
- Pre-hanged according to DIN 18101
- Suited for timber profile frames or standard frames made of steel

Frame

- Rebate cladding 16 x 60 mm, mitred and firmly glued to the jamb lining. 16 x 80 mm on request
- Jamb lining made of 25 mm chipboard, rebate cladding and decorative edge made of 12 MDF boards
- Decorative edge 16 x 60 mm, optionally 16 x 80 mm
- Adjustable for wall thickness -5 mm / + 15 mm
- Sound-absorbing seal inserted at the factory, mitred

Vertical view

Rebated

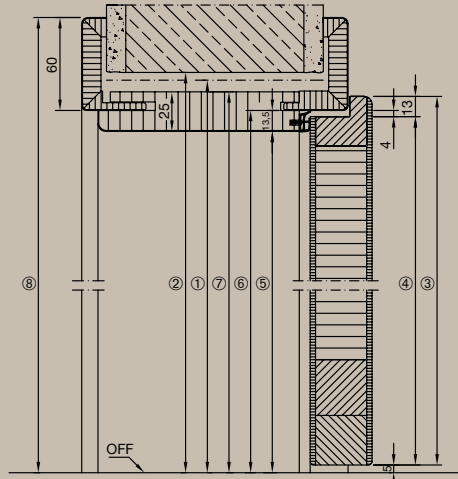

Flush

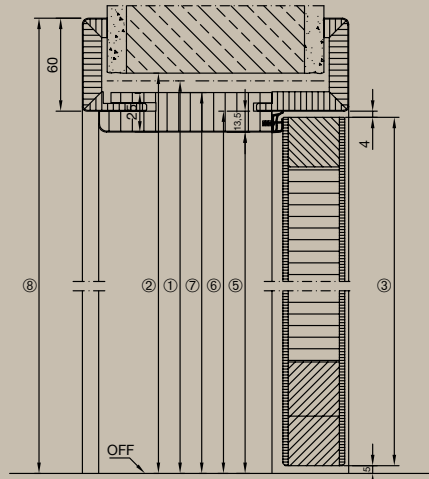

1	Nominal size height		1875	2000	2125	2250
2	Wall opening		1880	2005	2130	2255
3	Overall door leaf dimension	Rebated	1860	1985	2110	2235
		Flush	1847	1972	2097	2222
4	Leaf rebate dimension		1847	1972	2097	2222
5	Clear passage dimension		1843	1968	2093	2218
6	Frame hold dimension		1856	1981	2106	2231
7	Overall lining dimension		1868	1993	2118	2243
8	Overall cladding dimension for 60 mm cladding (for 80 mm cladding + 20 mm)		1916	2041	2166	2291

Frame types

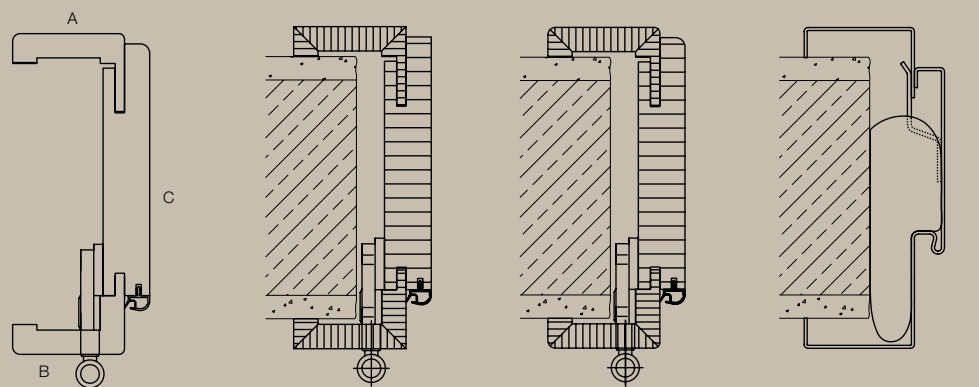

A: Decorative edge Timber frame, angular Timber frame, round edge Steel profile frame VarioFix
 B: Rebate cladding
 C: Jamb lining

Horizontal view – single leaf

Rebated

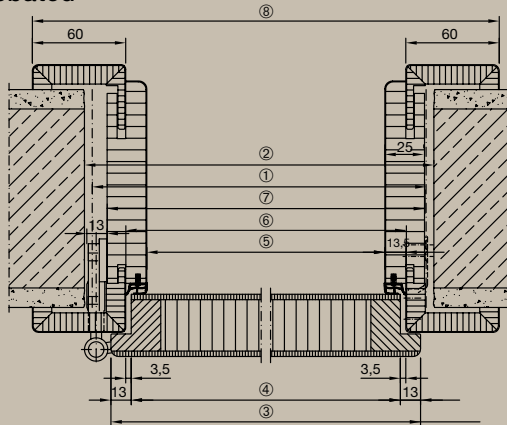

Flush

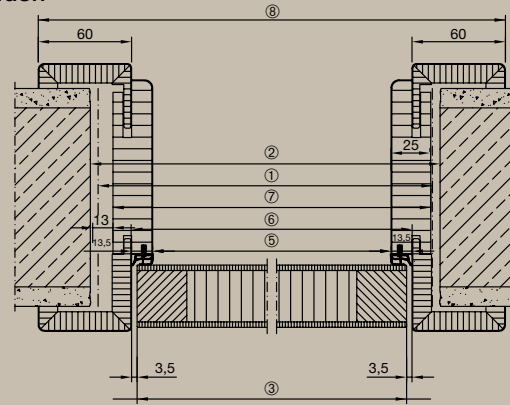

		625	750	875	1000	1125	1250
1 Nominal size width		625	750	875	1000	1125	1250
2 Wall opening		635	760	885	1010	1135	1260
3 Overall door leaf dimension	Rebated	610	735	860	985	1110	1235
	Flush	584	709	834	959	1084	1209
4 Leaf rebate dimension		584	709	834	959	1084	1209
5 Clear passage dimension		564	689	814	939	1064	1189
6 Frame hold dimension		591	716	841	966	1091	1216
7 Overall lining dimension		614	739	864	989	1114	1239
8 Overall cladding dimension		711	836	961	1086	1211	1336

Horizontal view – double leaf

Rebated

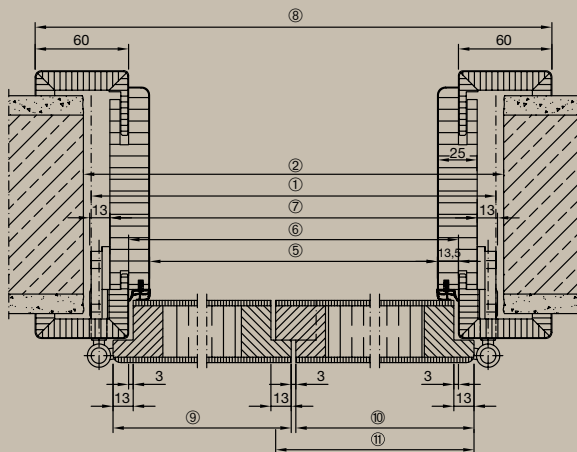

Flush

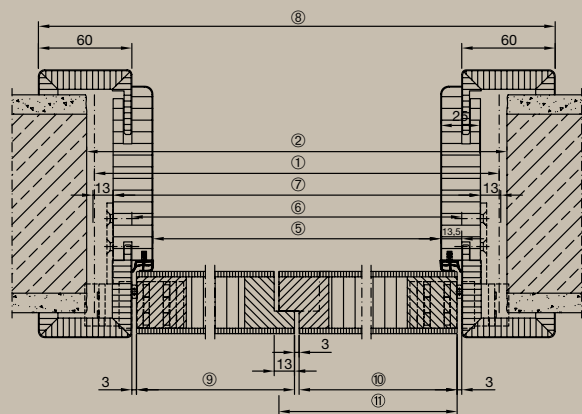

		1250	1375	1500	1750	1875	2000	2250	2500
1 Nominal size width		1250	1375	1500	1750	1875	2000	2250	2500
2 Wall opening		1260	1385	1510	1760	1885	2010	2260	2510
5 Clear passage dimension		1176	1301	1426	1676	1801	1926	2176	2426
6 Frame hold dimension		1203	1328	1453	1703	1828	1953	2203	2453
7 Overall lining dimension		1226	1351	1476	1726	1851	1976	2226	2476
8 Overall cladding dimension		1323	1448	1573	1823	1948	2073	2323	2573
9 Overall door leaf dimension Traffic leaf	Rebated	610	735	735	860	985	985	1110	1235
	Flush	597	722	722	847	972	972	1097	1222
10 Overall door leaf dimension Fixed leaf with meeting style*	Rebated	610	610	735	860	860	985	1110	1235
	Flush	597	597	722	847	847	972	1097	1222
11 Overall door leaf dimension Fixed leaf with counter rebate	Rebated	623	623	748	873	873	998	1123	1248
	Flush	610	610	735	860	860	985	1110	1235

* Only for Carolina door styles

All dimensions in mm

Hörmann: Quality without Compromise



Hörmann KG Amshausen, Germany



Hörmann KG Antriebstechnik, Germany



Hörmann KG Brandis, Germany



Hörmann KG Brockhagen, Germany



Hörmann KG Dissen, Germany



Hörmann KG Eckelhausen, Germany



Hörmann KG Freisen, Germany



Hörmann KG Ichttershausen, Germany



Hörmann KG Werne, Germany



Hörmann Alkmaar B.V., Netherlands



Hörmann Legnica Sp. z o.o., Poland



Hörmann Beijing, China



Hörmann Tianjin, China



Hörmann LLC, Montgomery IL, USA



Hörmann Flexon LLC, Burgettstown PA, USA



Shakti Hörmann Ltd., India

Hörmann is the only manufacturer worldwide that offers you a complete range of all major building products from one source. We manufacture in highly-specialised factories using the latest production technologies. The close-meshed network of sales and service companies throughout Europe, and activities in the USA and Asia, make Hörmann your strong partner for first-class building products, offering "Quality without Compromise".

GARAGE DOORS
OPERATORS
INDUSTRIAL DOORS
LOADING EQUIPMENT
HINGED DOORS
DOOR FRAMES